

## Titanium Machining

Titanium is one of the fastest growing materials used in aerospace applications. The prime rationale for designers to choose titanium in their designs is its relative low mass for a given strength level and its relative resistance to high temperature.

Titanium has long been used in aircraft engine front sections and will continue to be used there for the foreseeable future. In fact, due to its properties, titanium alloys are becoming more prevalent than ever before in structural and landing gear components.

One drawback of these alloys is their poor machinability. Kennametal has decades of experience in working with material providers (one of our divisions provides high-purity alloys for the industry), OEMs, and parts manufacturers.

Over the past few years, Kennametal has invested heavily in Research & Development to understand how to better machine titanium. Our research has led us to become the undisputed leader in titanium machining in the world, from engines to large components.

We would like to share some of this knowledge and are pleased to present the following guide to machine these materials, from understanding metallurgical properties to the best technologies to use.





## Expert Application Advisor • Titanium and Titanium Alloys

### ► Machinability of Titanium Alloys

Machining of titanium alloys is as demanding as the cutting of other high-temperature materials. Titanium components are machined in the forged condition and often require removal of up to 90% of the weight of the workpiece.

The high-chemical reactivity of titanium alloys causes the chip to weld to the tool, leading to cratering and premature tool failure. The low thermal conductivity of these materials does not allow the heat generated during machining to dissipate from the tool edge. This causes high tool tip temperatures and excessive tool deformation and wear.

Titanium alloys retain strength at high temperatures and exhibit low thermal conductivity. This distinctive property does not allow heat generated during machining to dissipate from the tool edge, causing high tool tip temperatures and excessive plastic deformation wear — leading to higher cutting forces. The high work-hardening tendency of titanium alloys can also contribute to the high cutting forces and temperatures that may lead

to depth-of-cut notching. In addition, the Chip-Tool contact area is relatively small, resulting in large stress concentration due to these higher cutting forces and temperatures resulting in premature failure of the cutting tool.

The low Modulus of Elasticity (Young's Modulus) of these materials causes greater workpiece spring back and deflection of thin-walled structures resulting in tool vibration, chatter and poor surface finish. Alpha ( $\alpha$ ) titanium alloys (Ti5Al2.5Sn, Ti8Al1Mo1V, etc.) have relatively low tensile strengths ( $\sigma_T$ ) and produce relatively lower cutting forces in comparison to that generated during machining of alpha-beta ( $\alpha$ - $\beta$ ) alloys (Ti6Al4V) and even lower as compared to beta ( $\beta$ ) alloys (Ti10V2Fe3Al) and near beta ( $\beta$ ) alloys (Ti5553).

A generous quantity of coolant with appropriate concentration should be used to minimize high tool tip temperatures and rapid tool wear. Positive-rake sharp tools will reduce cutting forces and temperatures and minimize part deflection.

### Case Study



Introducing Beyond BLAST™, a revolutionary insert platform with advanced coolant-application technology that makes cutting more efficient and effective — while extending tool life.

We took an entirely different approach to machining high-temperature alloys. We determined that the most effective way to deliver coolant would be to channel it through the insert, ensuring that it hits exactly where it does the most good. That means more efficient coolant delivery at a fraction of the cost of high-pressure coolant systems.

## Metallurgy

### ➤ Alpha ( $\alpha$ ) Alloys

Pure titanium and titanium alloyed with  $\alpha$  stabilizers, such as tin and aluminum (e.g., Ti5Al2.5Sn), are classified as  $\alpha$  alloys. They are non-heat treatable and are generally weldable. They have low to medium tensile strength, good notch toughness, and excellent mechanical properties at cryogenic temperatures.

### ➤ Titanium Alloys

Pure titanium (Ti) undergoes a crystallographic transformation, from hexagonal close packed, hcp (alpha,  $\alpha$ ) to body-centered cubic, bcc (beta,  $\beta$ ) structure as its temperature is raised through 1620°F / 882°C. Alloying elements, such as tin (Sn), when dissolved in titanium, do not change the transformation temperature, but elements such as aluminum (Al) and oxygen (O) cause it to increase. Such elements are called “ $\alpha$  stabilizers.” Elements that decrease the phase-transformation temperature are called “ $\beta$  stabilizers.” They are generally transition metals. Commercial titanium alloys are thus classified as “ $\alpha$ ,” “ $\alpha$ - $\beta$ ,” and “ $\beta$ .” The  $\alpha$ - $\beta$  alloys may also include “near  $\alpha$ ” and “near  $\beta$ ” alloys depending on their composition.

### ➤ Beta ( $\beta$ ) Alloys

Beta ( $\beta$ ) alloys contain transition metals, such as V, Nb, Ta, and Mo, that stabilize the  $\beta$  phase. Examples of commercial  $\beta$  alloys include Ti11.5Mo6Zr4.5Sn, Ti15V3Cr3Al3Sn, and Ti5553. Beta alloys are readily heat-treatable, generally weldable, and have high strengths. Excellent formability can be expected in the solution treated condition. However,  $\beta$  alloys are prone to ductile-brittle transition and thus are unsuitable for cryogenic applications. Beta alloys have a good combination of properties for sheet, heavy sections, fasteners, and spring applications.

### ➤ Alpha-Beta ( $\alpha$ - $\beta$ ) Alloys

These alloys feature both  $\alpha$  and  $\beta$  phases and contain both  $\alpha$  and  $\beta$  stabilizers. The simplest and most popular alloy in this group is Ti6Al4V, which is primarily used in the aerospace industry. Alloys in this category are easily formable and exhibit high room-temperature strength and moderate high-temperature strength. The properties of these alloys can be altered through heat treatment.



Near  $\alpha$ -alloy Ti6Al2Sn4Zr2, Mo showing alpha grains and a fine alpha-beta matrix structure.



Microstructure of  $\alpha$ -alloy Ti5Al2.5Sn.



Beta alloy Ti3Al8V6Cr4Mo4Zr.



Alpha-beta alloy Ti6Al4V showing primary alpha grains and a fine alpha-beta matrix structure.

## Titanium and Titanium Alloys Characteristics

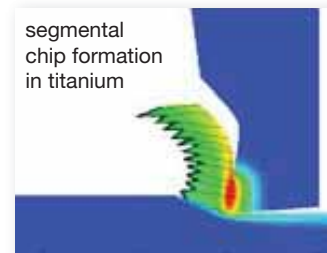
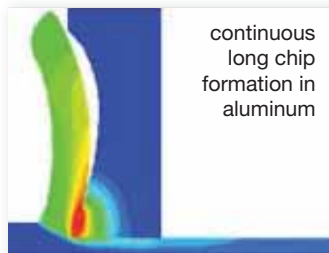
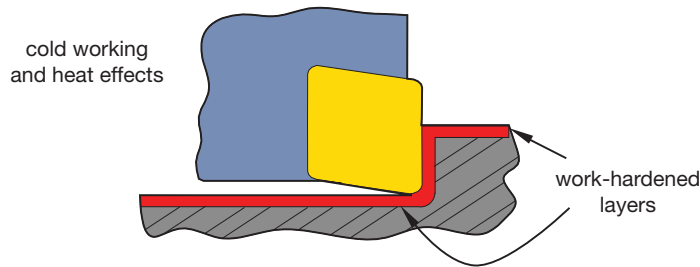

Titanium chips tend to adhere to the cutting edges and will be re-cut if not evacuated from edges. Plastic deformation sometimes occurs.

### ➤ Titanium and Titanium Alloys (110–450 HB) ( $\leq 48$ HRC)



Pure: Ti98.8, Ti99.9

Alloyed: Ti5Al2.5Sn, Ti6Al4V, Ti4Al2Sn4Zr2Mo, Ti3Al8V6Cr4Mo4Zr, Ti10V2Fe 3Al, Ti13V11Cr3Al, Ti5Al5Mo5V3Cr

### ➤ Material Characteristics

- Relatively poor tool life, even at low cutting speeds.
- High chemical reactivity causes chips to gall and weld to cutting edges.
- Low thermal conductivity increases cutting temperatures.
- Usually produces abrasive, tough, and stringy chips.
- Take precautionary measures when machining a reactive (combustible) metal.
- Low elastic modulus easily causes deflection of workpiece.
- Easy work hardening.

## Troubleshooting

Problem	Solution	
Depth-of-cut notch	<ol style="list-style-type: none"> <li>1. Avoid built-up edge.</li> <li>2. Increase the tool lead angle.</li> <li>3. Use tougher grades like KC5525™, KCU25™, KCM25™, or KCM35™ in -UP, -MP, or -RP geometries for interrupted cutting or KC725M™ or KCPK30™ in “S” edge geometries for Milling.</li> <li>4. Maintain speed and decrease feed rate simultaneously.</li> <li>5. Use MG-MS geometry in place of GP.</li> <li>6. Ensure proper insert seating.</li> <li>7. Increase coolant concentration.</li> <li>8. Depth of cut should be greater than the work-hardened layer resulting from the previous cut (&gt;0,12mm/.005”).</li> <li>9. Use strongest insert shape possible.</li> <li>10. Program a ramp to vary depth of cut.</li> </ol>	 <p>Depth-of-cut notch</p>
Built-up edge	<ol style="list-style-type: none"> <li>1. Maintain sharp or lightly honed cutting edges. Use ground periphery inserts and index often.</li> <li>2. Use GG-FS or GT-LF geometry in PVD grades KC5510™, KC5010™, and KCU10™.</li> <li>3. Increase speed.</li> <li>4. Increase feed.</li> <li>5. Increase coolant concentration.</li> </ol>	 <p>Built-up edge</p>
Torn workpiece surface finish	<ol style="list-style-type: none"> <li>1. Increase feed and reduce speed.</li> <li>2. Use positive rake, sharp PVD-coated grades KC5510 and KCU10.</li> <li>3. Increase speed.</li> <li>4. Increase coolant concentration.</li> </ol>	 <p>Torn workpiece surface finish</p>
Workpiece glazing	<ol style="list-style-type: none"> <li>1. Increase depth of cut.</li> <li>2. Reduce nose radius.</li> <li>3. Index insert to sharp edge.</li> <li>4. Do not dwell in the cut.</li> </ol>	

# The Importance of the Correct Use of Coolant

## ➤ Goal • Lowest Coefficient of Friction

A low coefficient of friction is developed by using proper coolant delivery. This results in lower temperature so the workpiece doesn't get soft and tool life is extended. Under pressure and direction, the coolant knocks chips off the cutting edges and provides anti-corrosive benefits for machine tool and work. There is a high correlation between the amount of coolant delivered and the metal removal rate.

For example, Kennametal drills are high-performance, solid carbide tools. To optimize their performance, they must be adequately cooled. With the proper coolant flow, tool life and higher maximum effective cutting speeds can be reached. In Milling and Turning processes, applying coolant using our newest technology — coolant delivered at the cutting edge, through-the-tool coolant, or coolant nozzles to each insert — is an optimal way to increase tool life and maximize productivity. Coolant nozzles direct a concentrated stream of coolant to the cutting edge, providing multiple benefits. First, the cutting edge and workpiece are kept as cool as possible. Second, the cutting edge and workpiece are also lubricated for a minimum coefficient of friction. Finally, the coolant stream effectively forces the cut chips away from the cutting

edge, thereby eliminating the possibility of recut chips. Provide a generous “volume” of coolant when machining titanium, and when applying drills and mills in a vertical application to improve chip evacuation and increase tool life. It is important to use a high coolant concentration to provide lubricity, which will aid in tool life, chip evacuation, and finer surface finishes. High-pressure coolant, either through the tool or through a line adjacent and parallel to the tool, should always be considered for increased tool life and production. Do not use multi-coolant lines. Use one line with 100% of the flow capacity to evacuate the chips from the work area.

## ➤ Coolant Considerations

Use synthetic or semi-synthetic at proper volume, pressure, and concentration. A 10% to 12% coolant concentration is mandatory. Through-coolant for spindle and tool can extend the tool life by four times. An inducer ring is an option for through-spindle flow.

Maximize flow to the cutting edges for best results. At least 3 gal/min (13 liter/min) is recommended, and at least 500 psi (35 bar) is recommended for through-tool-flow.

Machining Guides • Titanium Machining Guide

### Case Study

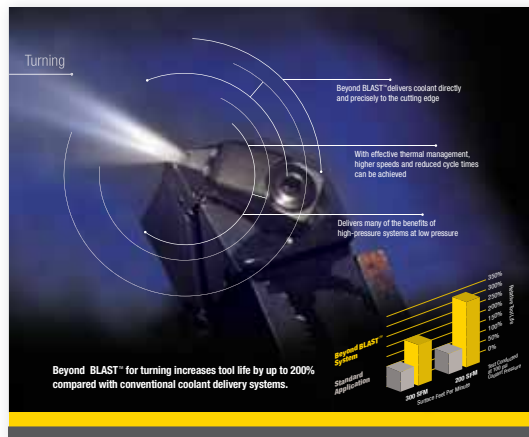

Beyond BLAST™ delivers coolant directly and precisely to the cutting edge.

With effective thermal management, higher speeds and reduced cycle time can be achieved.

Delivers many of the benefits of high-pressure systems at low pressure.



Optimum coolant delivery using Kennametal's Beyond BLAST technology



Inadequate coolant delivery



Marginally better coolant delivery

## Keep It Steady

### ➤ Rigidity and Stability

- Use gravity to your advantage.
- Horizontal spindles enable chips to fall away from your work.
- Horizontal fixturing necessitates use of “tombstones” or angle plates.

### ➤ Therefore...

- Keep work closest to strongest points of fixture.
- Keep work as close as possible to spindle/quill.
- High-pressure, high-volume, through-spindle coolant delivery will increase tool life tremendously (>4x).
- Know the power curve of your machine.
- Ensure sufficient axis drive motors for power cuts.
- Every setup has a weak link — find it!
- Rigidity will make or break your objectives:
  - Look for weak parts of machine structure and avoid moves that may compromise the rigidity.
  - Tool adaptation must fit the work — an HSK63 will not hold like an HSK100, nor will HSK or CV match KM™ adapters for rigidity.
  - Check for backlash in the machine’s spindle.
  - Identify your drawbar’s pull-back force.
  - Watch your adapter for fretting and premature wear — signs of overloading your cutting tool and damaging your spindle and bearings over time.

### ➤ Fixturing the Workpiece

- If vertical spindles are employed, your fixturing is still an important aspect.
- In either case, there may be directions of work movement that are not secured.
- Rigidity is paramount.
- Try to keep work close to the strongest points of the fixture to help avoid the effects of harmonics.

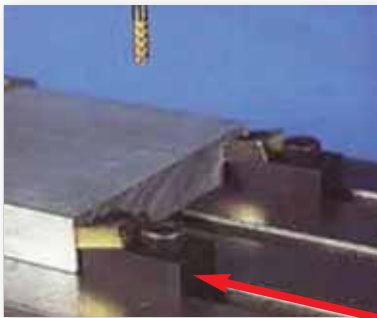

T-slot toe clamp

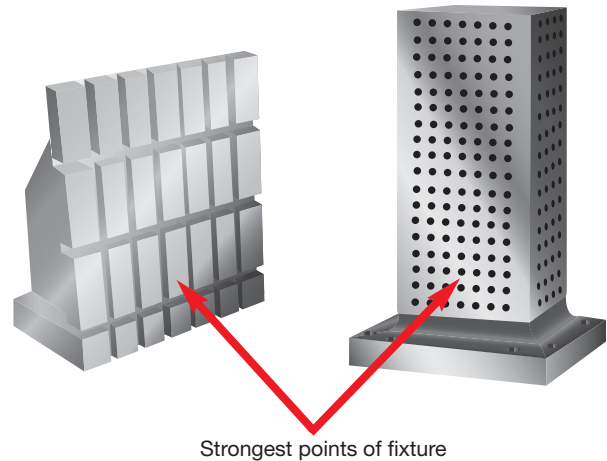

Strongest points of fixture

### ➤ Therefore...

- Keep work low and secure.
- Keep work as close as possible to spindle/quill.

The productivity factor between typically used cutting tools can easily be 4-to-1 in many cases. Older tools can be replaced by today’s tools if the entire system is modified where needed and accounted for where it is unalterable. Tool life can be increased by the same factor simply by changing from flood to through-tool-coolant delivery and utilizing our newest technology, coolant delivered directly at the cutting edge.

Don’t ask more of your machine than it can deliver. Most machines cannot constantly cut at a rate of 30 cubic inches (492cc) per minute. There are many usual failure or weak points in every system. They include, but are not limited to, drive axis motors, adapter interface, a weak joint, torque available to the spindle, machine frame in one or more axes, or compound angles relevant to machine stability and system dampening.



## ➤ The Importance of a Strong Spindle Connection

In the construction of today's modern aircraft, many component materials are switching to high-strength lighter materials like titanium to increase fuel efficiencies. To save time and money with this tougher-to-machine material, machinists are challenged to maximize metal removal rates at low cutting speeds and considerably higher cutting forces. Machine tool builders must also provide greater stiffness and damping in their spindles to minimize undesirable vibrations that deteriorate tool life and part quality.

Although all these advances add to greater productivity, the weakest point is often the spindle connection itself — needing high torque and overcoming high-bending applications.

Kennametal's response to this traditionally weak point has been with our proven KM™ system and now we are introducing the next generation KM4X™ System: the combination of the KM4X System's high clamping force and interference level lead to a robust connection and extremely high stiffness and bending capacity for unmatched performance in titanium machining.

## ➤ Overview of Existing Spindle Connection

To fulfill the increasing demand for high productivity, an important element to be considered is the tool-spindle connection. The interface must withstand high loads and yet maintain its rigidity. In most cases, it will determine how much material can be removed on a given operation until the tool deflection is too high or the onset of chatter.

High-performance machining can be accomplished with the use of high feeds and depths of cut. With the advances in cutting tools, there is a need for a spindle connection that makes possible the best utilization of the available power.

Several different types of spindle connection have been developed or optimized over the last few decades. The 7/24 ISO taper became one of the most popular systems in the market. It has been successfully used in many applications but its accuracy and high-speed limitations prevent it from growing further. The recent combination of face contact with 7/24 solid taper provides higher accuracy in the Z-axis direction, but this also presents



*Fig. 1 The various spindle connections commercially available today: 7/24 ISO taper, KM (ISO TS), HSK, and PSC.*

## KM4X — The Next Generation Spindle Connection System

- Heavy duty, rigid configuration with evenly distributed clamping force.
- Simple design enables front-loaded spindle designs.
- Balanced by design for high spindle speed capacity.
- Capable of performing in a wide range of operations from low speed, high torque to high speed, low torque.

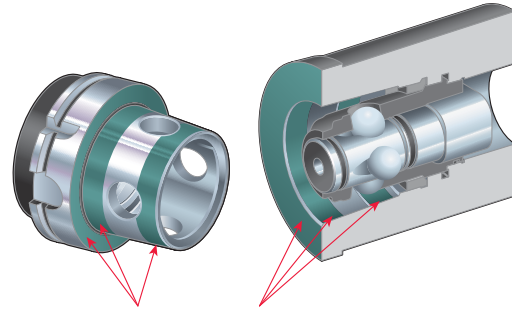

*KM4X 3-surface contact for improved stability and accuracy. Optimized clamping force distribution and interference fit provides higher stiffness.*

some disadvantages, namely the loss in stiffness at higher speeds or high side loads. Most of these tools in the market are solid and the spindles have relatively low clamping force.

In the early 80s Kennametal introduced the KV system, which was a shortened version of CAT V flange tooling with a solid face contact system. In 1985, Kennametal and Krupp WIDIA initiated a joint program to further develop the concept of taper and face contact interface and a universal quick-change system, now known as KM. This was recently standardized as ISO 26622. The polygonal taper-face connection known as PSC, now also standardized as ISO 26623 and in the early 90s HSK system started being employed on machines in Europe and later became DIN 69893 and then ISO 121.

Chart (Fig. 2) represents the load capacity of HSK, PSC, and KM4X. The shaded areas represent the typical requirements for heavy duty in various machining processes. KM4X is the only system that can deliver torque and bending required to achieve high-performance machining. Some systems may be able to transmit considerable amount of torque, but the cutting forces also generate bending moments that will exceed the interface's limits before torque limits are exceeded.

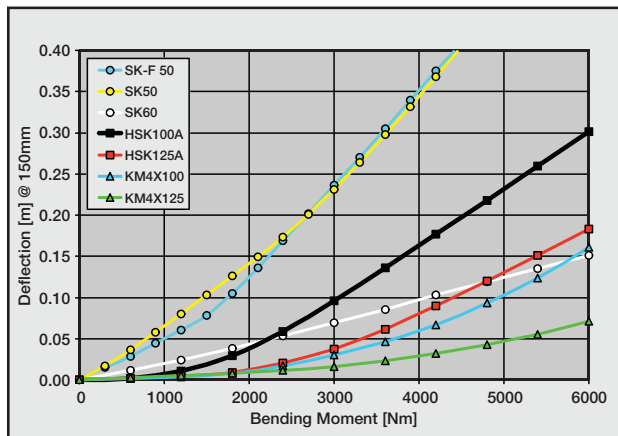
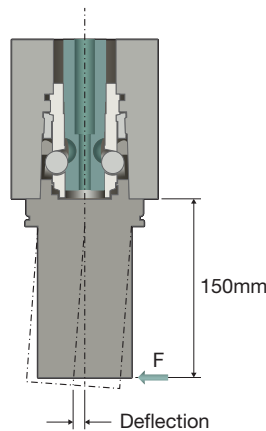
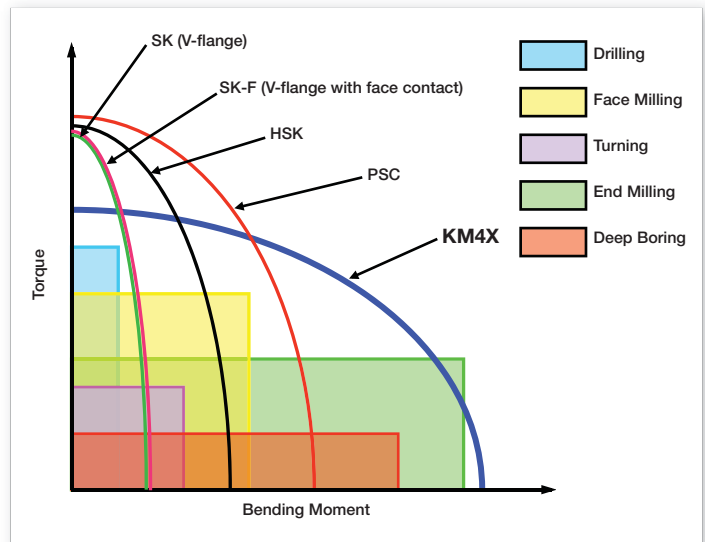

Fig. 2 Chart shows a comparison of Steep Taper with and without face contact, HSK and KM4X™.



As an example, an indexable helical cutter with 250mm projection from spindle face, 80mm in diameter generates 4620 Nm of bending moment and less than 900 Nm of torque.



## Choosing What's Right

When machining tough materials like titanium, cutting speeds are relatively low due to thermal effects on cutting tools. In response, machine tool builders have improved stiffness and damping on spindles and machine structures over the years. Spindles have been designed with abundant torque at low rotational speeds. Nevertheless, the spindle connection remains the weak link in the system.

The spindle connection must provide torque and bending capacity compatible with the machine tool specifications and the requirements for higher productivity. It becomes obvious that in end-milling applications where the projection lengths are typically greater, the limiting factor is bending capacity of the spindle interface.

With more materials that are tougher to machine and require considerably higher cutting forces from the machine tool, choosing wisely on the spindle interface to maximize cutting edge performance is the key to success.

The KM spindle connections greatly outperform the conventional 7/24 steep taper and its face taper contact derivative, HSK and PSC systems with their greater stiffness advantages to help minimize undesirable vibrations, gaining the best possible productivity from the machine tool. The KM4X is the best large, heavy-duty spindle connection, where optimal rigidity is necessary. It has superb balance between bending and torsion capabilities from the machine tool.

## Dealing with High Cutting Tool Forces

### ➤ Sharp edge

- Lower tool pressure.
- Clean cutting action.
- Weakest.

### ➤ T-land edge

- Strengthens edge; puts edge in compression.
- Feed dependent.

### ➤ Honed edge

- Stronger than sharp.

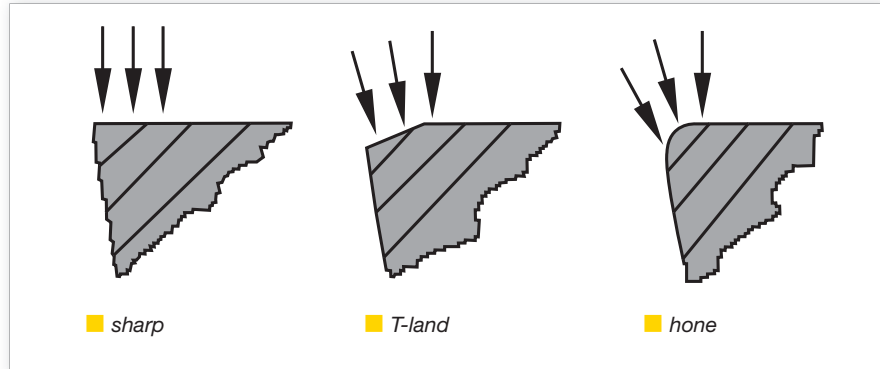

**Use Positive Rake Tool Geometries!**

### ➤ Important Carbide Material Properties

- Strength to resist high cutting forces.
- Deformation resistance and high hardness at temperatures encountered at cutting edge.
- Toughness to resist depth-of-cut notching.

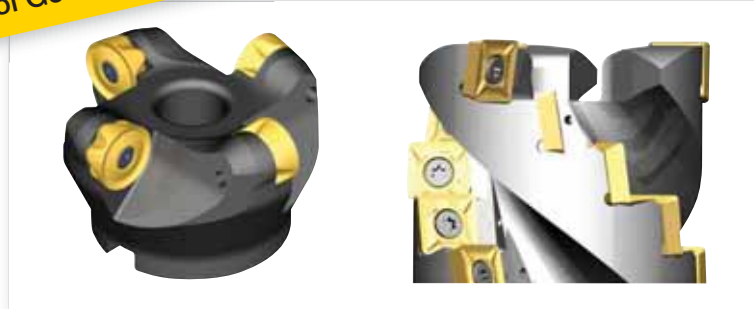

### The TiAlN Advantage

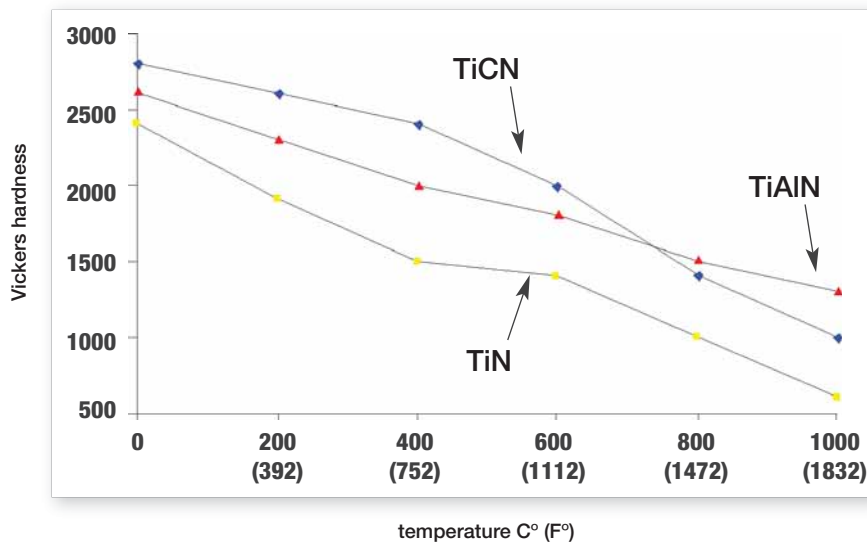



# KM4X™

**The Latest Innovation in Spindle Interface Technology!**  
**Dramatically increase your metal removal rates when machining high-temperature alloys!**

- Run jobs at significantly faster feeds and speeds than is achievable with other spindle interfaces.
- Unique use of clamping force and interference level increases clamping capability 2 to 3 times.
- You experience lower cost of ownership, increased throughput, and superior results.

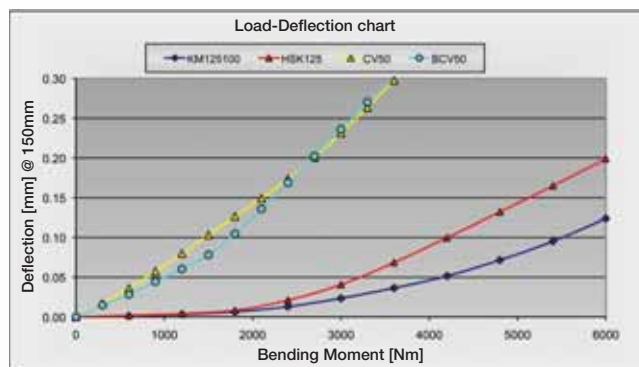

Visit [www.kennametal.com](http://www.kennametal.com) or contact your local Authorized Kennametal Distributor.

## Horsepower Calculations • The 10x Factor

Titanium is 10x harder than aluminum ISO. In order to machine titanium properly, it's necessary to make calculations based on the Brinell Hardness (HB) scale. To easily calculate the appropriate horsepower, the Kennametal website provides engineering calculators.

The example shown on page A32 (Figure 4) represents a Kennametal Face Milling application with high-shear cutters. Estimated machining conditions, force, torque, and power are shown based on the HB. The following steps guide you through the procedure for utilizing the KMT calculator.

### Step 1:

Type in the following URL:  
[http://www.kennametal.com/calculator/calculator\\_main.jhtml](http://www.kennametal.com/calculator/calculator_main.jhtml)  
 See Figure 1.

Or, from the Kennametal home page, click:

- Customer Support, then
- Metalworking, then
- Reference Tools, then
- Calculators

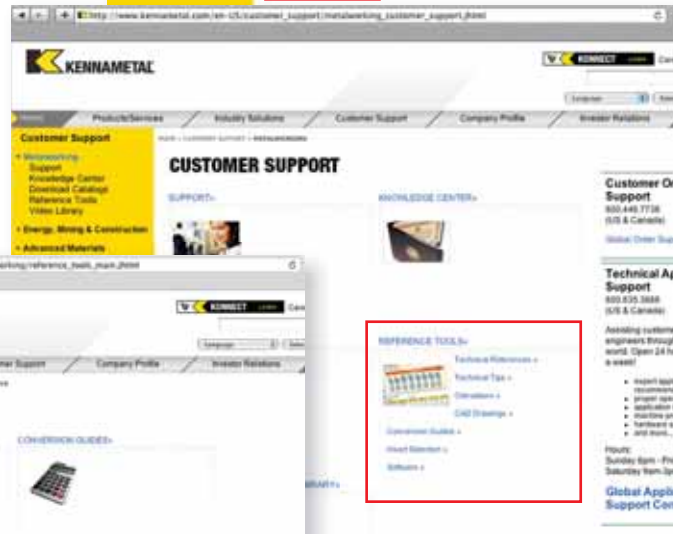

(continued)

(continued)

➤ **Step 2:**  
Select Face Milling  
See Figure 2.

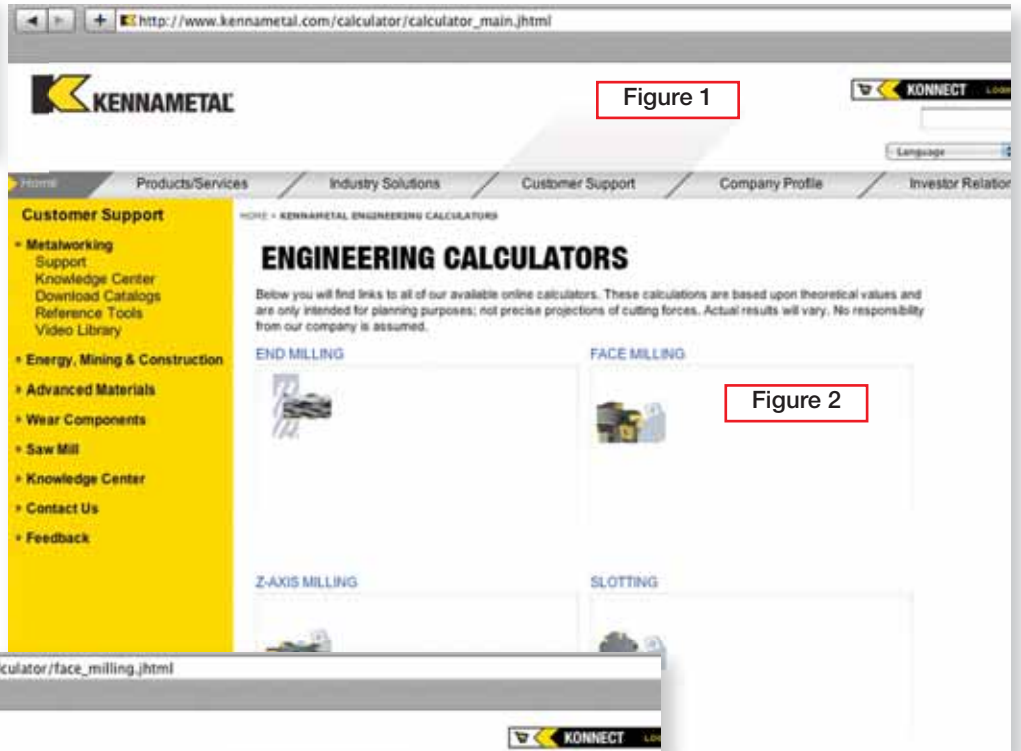

Figure 1

Figure 2

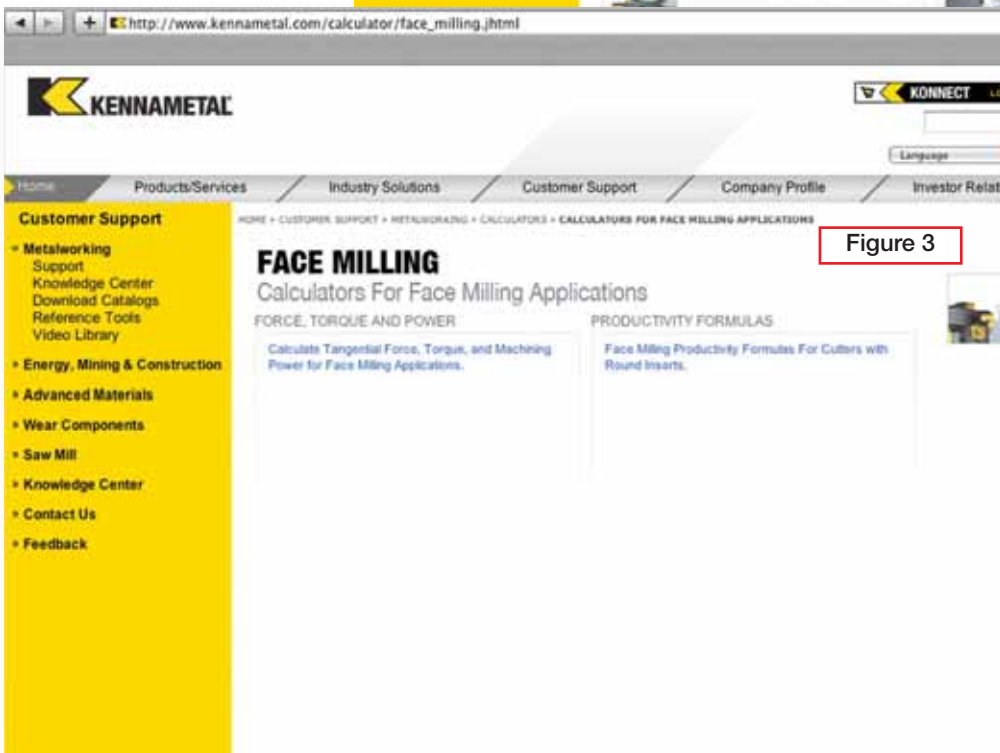
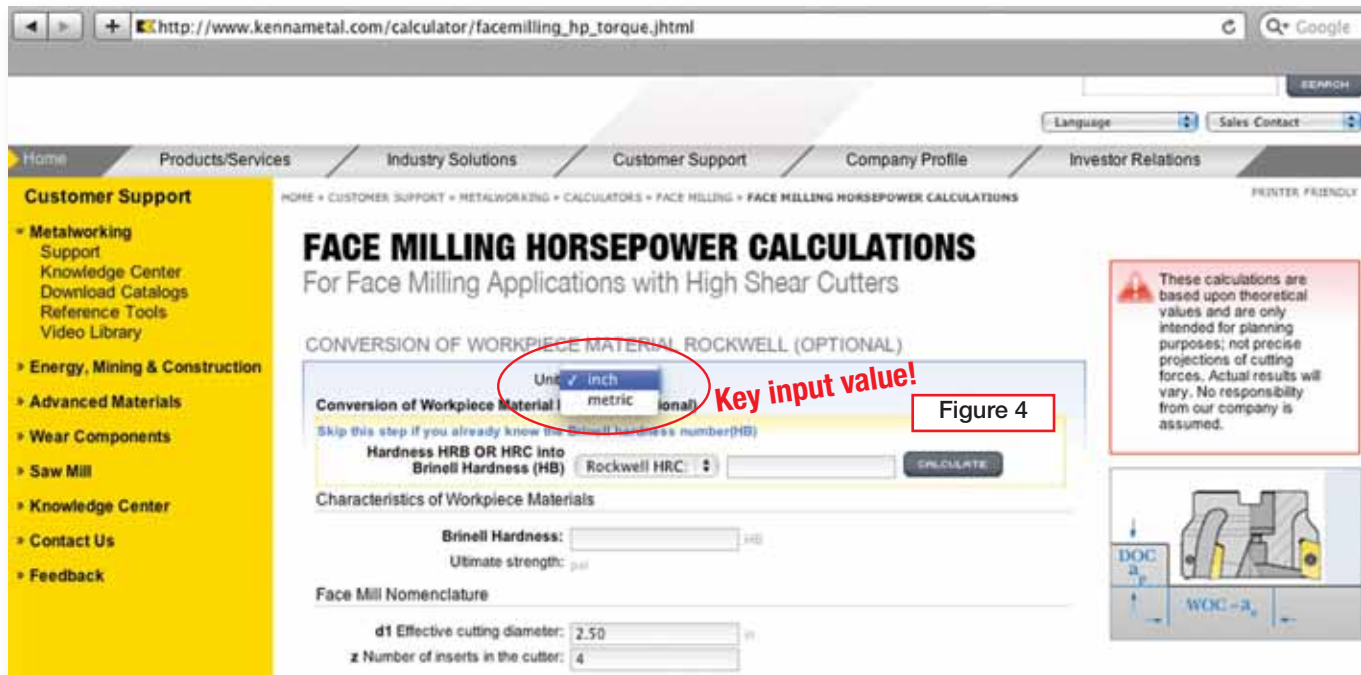

Figure 3

➤ **Step 3:**  
Make the appropriate measurement selection for Torque and Power (see Figure 3 on next page).  
In the following example (see page A32, Figure 4), “inch” has been chosen.





NOTE: Inch values used for illustration purposes only, metric available on the website.

### Example Explanation Figure 4

The “tuning knobs” that bring the predetermination of cutting forces closest to accuracy include the machinability factor, a choice of tool conditions (new or worn edges), consideration of the machine’s drives, and most importantly, the material’s ultimate tensile strength converted from hardness. The calculator is designed for a variety of applications and, in this example, face mills.

In this example of a real-life application, use of a .63 value for titanium would generate a horsepower value of 3.3, which is not close to the actual power required. The calculator accurately predicts the torque at the cutter which, in this case, was 45% of the load meter — given 740 lbf-ft. rating —  $.45 \times 740 = 0.333$  lbf-ft. For the machine’s horsepower rating of 47, the resulting horsepower required for this cut would be 21 hp. The calculator shows about 12 hp and can be tuned by changing the “p” factor or machine efficiency factor.

(continued)

(continued)

NOTE: Inch values used for illustration purposes only; metric available on the website.

### Calculated Force, Torque, and Required Power

Tangential cutting force, lbs	Torque at the cutter		Machining power, hp	
	in. lbs.	ft. lbs.	at the center	at the motor
1495.1	1868.9	155.7	6.3	7.0
Tangential cutting force, N	Torque at the cutter		Machining power, kW	
	—	N-m	at the center	at the motor
6650.5	—	211.1	4.7	5.2